

MAX™ EX



Installation & Operation Manual

**ClearOne.**

**Table of Contents**

Introduction ..... 1

Service and support ..... 1

Product returns ..... 1

Important safety information ..... 2

Unpacking ..... 3

Getting Started ..... 4

Connecting your conferencing phone ..... 4

Connecting additional MAX EX phones ..... 4

Connecting to a digital phone line ..... 5

Using your MAX EX conferencing phone ..... 6

User Options ..... 8

Call features ..... 8

Programming features ..... 9

Tones and alerts ..... 11

Maintenance ..... 12

Caring for your MAX EX ..... 12

Electrical considerations ..... 12

Troubleshooting ..... 12

Appendix ..... 14

Specifications ..... 14

Compliance ..... 15

Warranty ..... 17

MAX EX Installation and Operation Manual  
 ClearOne Part No. 800-158-015 September 2006 (Rev. 3.1)  
 U.S. Patent No. D499,392.

© 2005 ClearOne Communications Inc. All rights reserved. No part of this document may be reproduced in any form or by any means without written permission from ClearOne Communications. ClearOne Communications reserves specific privileges. Information in this document is subject to change without notice.

**Introduction**

Thank you for purchasing the ClearOne MAX™ EX expandable conferencing phone. MAX EX provides premium, full-duplex audio to small conference rooms as a single unit and to larger rooms as an expanded system. Up to four MAX EX units can be linked, expanding not only microphone coverage but loudspeaker coverage and control access as well. This creates even distribution of sound for a more natural communications experience.

Setting up the MAX EX conferencing phone is extremely easy and requires only three connections: power, telephone line and the base unit to the conferencing phone. And, the familiar keypad design ensures users will be comfortable using the phone, reducing the need for training and support.

- **Expandable.** MAX EX is ideal for conference rooms and provides complete microphone and loudspeaker coverage and easy access to controls.
- **Superior Audio.** The clear, full sound of the MAX EX facilitates more natural interaction among participants.
- **Easy to Use.** The intuitive, user friendly controls are simple to operate.

**Service and support**

If you need additional information on how to set up or operate your MAX EX conferencing phone, please contact us. We welcome and encourage your comments so we can continue to improve our products and better meet your needs.

**Technical Support**

Tel: 1-800-283-5936(USA) or 1-801-974-3760  
 Fax: 1-801-977-0087  
 E-mail: tech.support@clearone.com  
 Web: www.clearone.com

**Sales and Customer Service**

Tel: 1-800-945-7730 (USA) or 1-801-975-7200  
 Fax: 1-800-933-5107 (USA) or 1-801-977-0087  
 E-mail: sales@clearone.com

**Product returns**

All product returns require a return materials authorization (RMA) number. Please contact ClearOne Technical Support before attempting to return your product. Make sure you return all the items that shipped with your product.

## ⚠ Important safety information

Read the safety instructions before first use of this product. This conferencing phone is not designed for making emergency telephone calls when the power fails. Make alternative arrangements for access to emergency services.

- Read and understand all instructions and follow all warnings marked on the product.
- Unplug this product from the wall outlet before cleaning. Do not use liquid cleaners or aerosol cleaners. Use a damp cloth for cleaning.
- Do not use this product near water, for example, near a bathtub, washbowl, kitchen sink, or laundry tub, in a wet basement, or near a swimming pool.
- Do not place this product on an unstable cart, stand, or table. The product may fall, causing serious damage to the product.
- Slots and openings in the cabinet and the back or bottom are provided for ventilation, to protect it from overheating, these openings must not be blocked or covered. Never push objects of any kind through cabinet slots as they may touch dangerous voltage points or short out parts that could result in a risk of fire or electric shock.
- This product should never be placed near or over a radiator or heat register. This product should not be placed in a built-in installation unless proper ventilation is provided.
- This product should be operated only from the type of power source indicated on the marking label. If you are not sure of the type of power supply in your location, consult your dealer or local power company.
- Do not overload wall outlets and extension cords as this can result in fire risk or electric shock.
- Never spill liquid of any kind on the product.
- To reduce the risk of electric shock, do not disassemble this product. Opening or removing covers may expose you to dangerous voltages or other risks. Incorrect reassembly can cause electric shock during subsequent use.
- Unplug this product from the wall outlet and refer servicing to qualified service personnel under the following conditions:
  - a. When the power supply cord or plug is damaged or frayed.
  - b. If liquid has been spilled into the product.
  - c. If the product does not operate normally by following the operating instructions.
  - d. If the product has been dropped or damaged.
  - e. If the product exhibits a distinct change in performance.
- Avoid using a telephone during an electrical storm. There may be a remote risk of electric shock from lightning.
- Do not use this product to report a gas leak in the vicinity of the leak.
- Do not use this product near intensive care medical equipment or by persons with pacemakers.
- This product can interfere with electrical equipment such as answering machines, TV sets, radios, computers and microwave ovens if placed too close.

### Telephone wiring and jack information

To reduce the risk of fire or injury to persons, read and follow these instructions:

- Use caution when installing or modifying telephone lines.
- Never install telephone wiring during an electrical storm.
- Never install telephone jacks in wet locations unless jack is specifically designed for wet locations.
- Never touch uninsulated telephone wires or terminals unless the telephone line is disconnected at the network interface.

## Save these instructions

## Unpacking

Carefully place the conferencing pod and base unit on a level surface. Ensure you have received all items shown below.

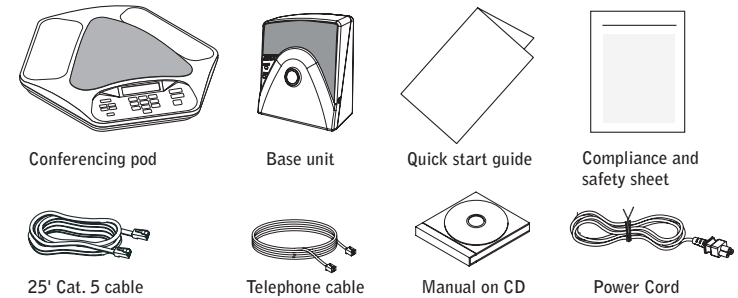



Figure 1a. MAX EX parts

 **Note:** ClearOne is not responsible for product damage incurred during shipment. You must make claims directly with the carrier. Inspect your shipment carefully for obvious signs of damage. If the shipment appears damaged, retain the original boxes and packing material for inspection by the carrier. Contact your carrier immediately.

The following items are included in the MAX Expansion Kit.

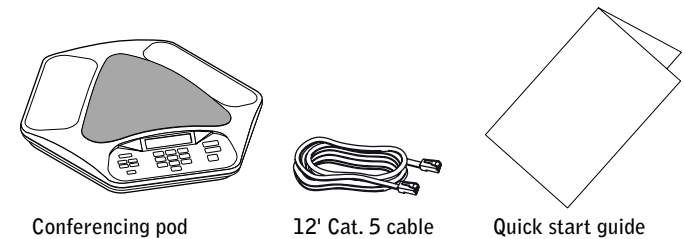



Figure 1b. MAX EX Expansion kit

	<b>CAUTION</b> RISK OF ELECTRIC SHOCK DO NOT OPEN	
THE LIGHTNING FLASH AND ARROW HEAD WITHIN THE TRIANGLE IS A WARNING SIGN ALERTING YOU OF DANGEROUS VOLTAGE INSIDE THE PRODUCT	CAUTION: TO REDUCE THE RISK OF ELECTRIC SHOCK, DO NOT REMOVE COVER (OR BACK) NO USER SERVICEABLE PARTS INSIDE. REFER SERVICING TO QUALIFIED SERVICE PERSONNEL	THE EXCLAMATION POINT WITHIN THE TRIANGLE IS A WARNING SIGN ALERTING YOU OF IMPORTANT INSTRUCTIONS ACCOMPANYING THE PRODUCT.
SEE MARKING ON BOTTOM / BACK OF PRODUCT		

**WARNING: TO PREVENT FIRE OR ELECTRICAL SHOCK HAZARD, DO NOT EXPOSE THIS PRODUCT TO RAIN OR MOISTURE.**

Getting Started

Connecting your conferencing phone

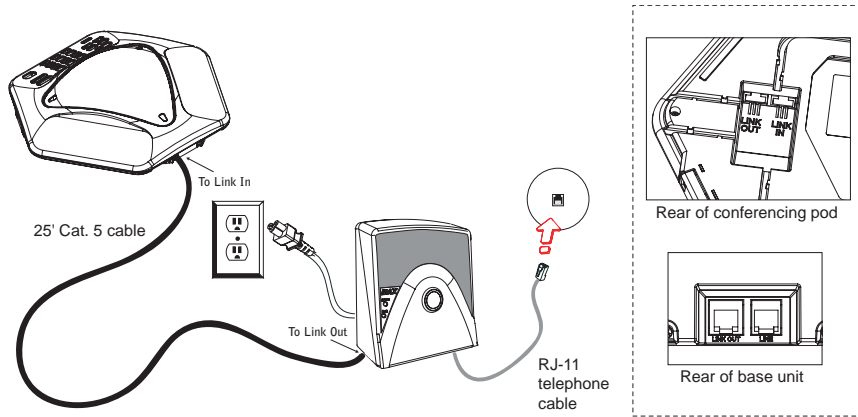

Figure 2. Connecting MAX EX

1. Connect the Cat. 5 cable from the Link Out jack on the base unit to the Link In jack on the conferencing pod.
2. Connect the base unit to the telephone jack using the RJ-11 telephone cable.
3. Connect the power cord to the base unit and plug it directly into an electrical outlet.

Connecting additional MAX EX phones

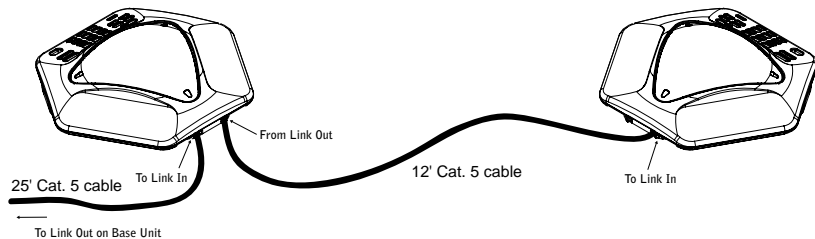

Figure 3. Connecting additional units

1. Connect the 12' Cat. 5 cable to the Link Out jack on the first phone and the Link In jack on the second phone.
2. Continue linking up to three additional MAX EX phones in the same fashion. A total of four units may be connected.

Connecting to a digital phone line

WARNING! Do not connect the conference phone directly to a digital (PBX) line, PERMANENT DAMAGE MAY RESULT.

If you have digital (PBX) telephone service, you need to run an analog extension from the PBX (recommended for best performance) or use a digital-to-analog telephone line converter. For more information, contact ClearOne Technical Support.

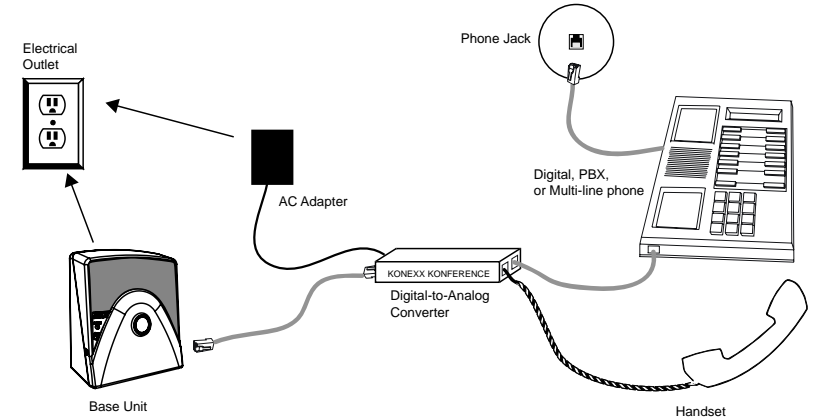

Figure 4. Connecting the base unit to digital-to-analog converter

1. Connect one end of the telephone cable into the phone jack on the back of the base unit and the other end into the digital-to-analog converter.
2. Connect the converter's power adapter into an electrical outlet.
3. Connect a second telephone cable from the converter to a digital or PBX phone. Consult the converter user manual for more information.
4. Plug the base unit into an electrical outlet and connect to the pod.

## Using your MAX EX conferencing phone

### To make a call

1. Press the **ON/OFF** key. You will hear a dial tone.
2. Dial the number as you would on a standard phone. The number appears on the LCD screen.

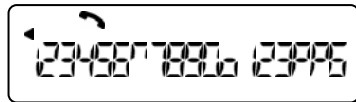



Figure 5. Dialing screen

 **Note:** You can also predial the number while in Standby (inactive) mode and press the **ON/OFF** key to connect the call. Press and hold the pound key (#) to enter a pause in the dialing string.

### To answer a call

- Press any key (except the star key (\*), **MUTE**, **VOLUME UP**, or **VOLUME DOWN**) on the keypad to answer the call. When there is an incoming call, the phone rings and the LEDs on the phone and the phone icon on the LCD screen flash.

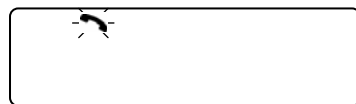

Figure 6. Incoming call

### To end a call

- Press the **ON/OFF** key. This will disconnect the call and return the phone to Standby mode.

### To redial a number

1. Press the **ON/OFF** key. You will hear a dial tone.
2. Press **REDIAL** to dial the last number called.

**Note:** You can also press **REDIAL** while in Standby mode to display the last number called. To connect the call, press the **ON/OFF** key.

### To adjust ringer volume

- While the phone is ringing, press **VOLUME UP** or **VOLUME DOWN**.
- While the phone is inactive, press **VOLUME UP** or **VOLUME DOWN**. The ringer melody will play once at the new level.

### To mute the call

- While on a call, press **MUTE** to mute the microphones (loudspeakers are not muted).
- Press again to unmute.

### To access your speed dial number

- Press the **SPEED DIAL** key. This feature must be programmed before use. See page 10.

### To access your service center

- While in Standby mode, press and hold the **0** key for 2 seconds. This feature must be programmed before use. See page 10.

### To store a number in the phonebook

1. Enter the phone number you want to store while conferencing pod is in Standby mode.
2. Press and hold the **PHONEBOOK/EDIT** key until the Phonebook and Program icons appear on the LCD screen.
3. Assign a Phonebook location (0-9) by pressing the corresponding number key.
4. Press **PHONEBOOK** again to save the entry.  You will hear a confirmation tone.
5. To exit Phonebook Edit mode before saving the entry, press **CLEAR**.

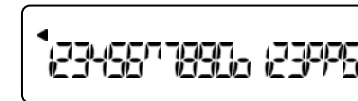
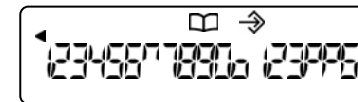

Figure 7. Adding Phonebook entries



**Note:** You can easily add the last number you dialed to the Phonebook. Simply press **REDIAL** to display the phone number and follow steps 2-5. Press & hold the "1" key to enter a hyphen or the "\*" key to enter a space in the number.

### To make a call using the Phonebook

1. Press **PHONEBOOK**.
2. Press the number key (0-9) that corresponds with the speed dial location. The stored number will appear on the LCD screen.
3. Press **ON/OFF** to dial the number.

**Note:** You can also press the **ON/OFF** button to get a dial tone before entering the Phonebook. This will cause the number to dial as soon as you select the speed dial location.

## User Options

### Call options

In addition to the basic phone operations described in the previous section, you can perform any of the following functions during a call: temporarily change to tone dialing, send a flash signal, display phone number and adjust speaker volume.

#### To temporarily enable tone dialing

If you have programmed the phone to use pulse dialing (see page 9), you may need to temporarily change to tone dialing during a call to access voicemail systems, enter pass-codes or extensions. To temporarily change to tone dialing:

- Press the star (\*) key. A special character appears on the LCD screen. All numbers entered after this character will use tone dialing. When the call is finished, the dialing mode will revert to pulse.

**Note:** When more than 18 characters are entered, a scroll icon appears on the LCD display and the numbers scroll from right to left.

#### To send a Flash signal

If your telephone service includes call transfer, call waiting, or conference calling, you can use the Flash key. Refer to your local telephone service for details.

#### To display your local number during a call

- Press **CLEAR**. The phone number will appear. This feature must be programmed before use. See page 10.

#### To adjust loudspeaker volume

- Press the **VOLUME UP** key while on a call to increase volume.
- Press the **VOLUME DOWN** key while on a call to decrease volume.

#### To turn the ringer on/off

- While in standby, press and hold the star (\*) key. The Ringer Off icon will illuminate when the ringer is turned off. The icon will not

appear when the ringer is on.

**Note:** When the ringer is off, LEDs will still flash to indicate an incoming call.

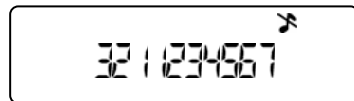

Figure 8. Ringer Off icon.

#### To mute during ringing

- Press the star (\*) or the **MUTE** key to mute the ringer for the duration of the ringing.

**Note:** This only mutes the current ring. Once a new call comes in, the ringer will not be muted.

### Programming options

To allow for individual preferences and enhance ease of use, eight features can be programmed: ringer melody, dialing mode, flash duration, local phone number, speed dial for conferencing services, speed dial for service center, country setting and AGC/ALC. You may also restore factory defaults.

#### To change ringer melody

- Press and hold the **REDIAL/PROG** key until the Program icon appears on the LCD screen.
- Press **1** to enter the Ringer Melody menu. There are five available melodies.
- Press **REDIAL/PROG**. The current melody selection flashes.
- Press keys **1–5** to play the corresponding melody. The selected melody plays once.
- Press **REDIAL/PROG** to save the selection. Press **CLEAR** to exit programming.



Figure 9. Programming options

#### To change dialing mode

- Press and hold the **REDIAL/PROG** key until the Program icon appears on the LCD screen.
- Press **2** to enter the Dialing Mode menu. There are two dialing modes: tone and pulse. The current dialing mode is shown on the screen (T for tone, P for pulse).
- Press **REDIAL/PROG**. The current mode flashes.
- Press **1** to select tone or **2** to select pulse.
- Press **REDIAL/PROG** to save the selection. Press **CLEAR** to exit.

#### To change flash duration

- Press and hold the **REDIAL/PROG** key until the Program icon appears on the LCD screen.
- Press **3** to enter the Flash Duration menu. The current duration is shown in milliseconds. There are five duration settings: 600, 300, 150, 100 and 80.
- Press **REDIAL/PROG**. The current duration flashes.
- Press keys **1–5** to select a new duration setting.
- Press **REDIAL/PROG** to save the selection. Press **CLEAR** to exit.

### To program local phone number

1. Press and hold **REDIAL/PROG** until the Program icon appears on the LCD screen.
2. Press **4** to enter the user phone number menu.
3. Press **REDIAL/PROG**.
3. Enter the local phone number.
4. Press **REDIAL/PROG** to save the number. Press **CLEAR** to exit.

 **Note:** Press & hold the "1" key to enter a hyphen or the "\*" key to enter a space in the number. Use **CLEAR** to delete the old number before entering a new number.

### To program speed dial number

1. Press and hold **REDIAL/PROG** until the Program icon appears on the LCD screen.
2. Press **5** to enter the Speed Dial menu.
3. Press **REDIAL/PROG**.
4. Enter the phone number.
5. Press **REDIAL/PROG** to save the number. Press **CLEAR** to exit.

 **Note:** Press & hold the "1" key to enter a hyphen or the "\*" key to enter a space in the number. Use **CLEAR** to delete the old number before entering a new number.

### To program service center number

1. Press and hold the **REDIAL/PROG** key until the Program icon appears on the LCD screen.
2. Press **6** to enter the service center menu.
3. Press **REDIAL/PROG**.
4. Enter the number you want the **0** key to dial.
5. Press **REDIAL/PROG** to save the number. Press **CLEAR** to exit.

 **Note:** Press & hold the "1" key to enter a hyphen or the "\*" key to enter a space in the number. Use **CLEAR** to delete the old number before entering a new number.

### To program country setting

1. Press and hold the **REDIAL/PROG** key until the Program icon appears on the LCD screen.
2. Press **7** to enter the service center menu.
3. Press **REDIAL/PROG**.
4. Press the number key that corresponds with desired country.

1 = US/Canada/China/Japan/ Mexico/Singapore	4 = South Africa
	5 = Brazil
2 = Europe CTR21	6 = New Zealand
3 = Australia	7 = South Korea

5. Press **REDIAL/PROG** to save the selection. Press **CLEAR** to exit.

### To program the Automatic Gain Control (AGC) and Automatic Level Control (ALC) settings

1. Press and hold the **REDIAL/PROG** key until the Program icon appears on the LCD screen.
2. Press and hold the **8** key. The current AGC setting number will be displayed on the LCD screen.
3. Press **REDIAL/PROG**. The current setting number will flash.
4. Enter a new setting number using the table.
5. Press **REDIAL/PROG** to confirm selection. Press **CLEAR** to exit.

Setting	Speaker AGC	Microphone ALC
1	On	On
2	On	Off
3	Off	On
4	Off	Off

### To restore factory defaults

1. Press and hold the **REDIAL/PROG** key until the Program icon appears on the LCD screen.
2. Press and hold the **9** key. The number 8 appears across the LCD screen.
3. Press **REDIAL/PROG** to confirm selection. Press **CLEAR** to exit.

 **Note:** The feature will not reset the country setting. It will maintain the user-defined country setting.

### Tones and alerts

Tone/Alert	Description
<b>Confirmation</b>	A tone will play upon successful programming entry.
<b>Reject</b>	A tone will play if you attempt to do any of the following: <ul style="list-style-type: none"> <li>• enter an invalid programming entry</li> <li>• use a speed dial key that has not been programmed (speed dial or service center)</li> <li>• enter a 45th digit when predialing</li> <li>• enter a 17th digit for user phone number</li> <li>• enter a 31st digit for speed dial key (One-Touch Conferencing or service center)</li> </ul>

## Maintenance

### Caring for your MAX EX

- Follow all warnings and instructions marked on your MAX EX.
- Unplug base unit and conferencing pod from the wall outlet before cleaning.
- Do not use liquid or aerosol cleaners. Use a damp cloth moistened with water to clean the outside of your conferencing pod or base unit and power supply.

### Electrical considerations

- Use only the power adapter that comes with your conferencing phone.

### Troubleshooting

If you are having trouble with your MAX EX, it might be improperly set up or other equipment might be malfunctioning. To begin, check for the following or consult the chart on the next page:

- The MAX EX base unit is plugged into the proper volt electrical outlet and its power light is on.
- Make sure cables are securely connected.
- The equipment the other party is using is comparable in quality to your MAX EX conferencing phone and is working properly. While the MAX EX works with speakerphones, cell phones, handsets or installed conferencing systems, the quality of the conference will be impacted if the party you are conferencing with has poor quality equipment.

If you hear	It could be that	Try this
<b>No dial tone</b>	Base unit is not connected to telephone jack.  You are not using an analog phone line.	Connect the base unit to the telephone jack using the supplied telephone cable.  Check that you are using an analog phone line. Consult your IT department for help.
<b>Static or noise</b>	You have a bad telephone connection.  You have a bad telephone line.  The other party's room is too noisy.	Place the call again to see if another line provides a better connection.  Plug a working phone into the phone jack. If the line is still noisy, call your telephone company.  Ask the other party to turn off noisy equipment.
<b>Calls can come in, but you can't dial out.</b>	The dialing mode (tone or pulse) is set incorrectly for your service.	See page 10 for instructions on changing the dialing mode.
<b>Poor audio</b>	The equipment on the far end is of lesser quality.	The equipment should be upgraded. Participants can try sitting closer to equipment and eliminate background noises.



## Appendix

### Specifications

#### DIMENSIONS (W x D x H)

Phone section: 10.5" x 10.5" x 3"  
(26.7 cm x 26.7 cm x 7.6 cm)  
Base unit: 4.25" x 5.5" x 2.5"  
(10.8 cm x 14 cm x 6.4 cm)

#### WEIGHT

Phone section: 2.7 lb (1.2 kg)  
Base unit: .6 lb (0.27 kg)  
Shipping: 10 lb (4.5 kg)

#### ENVIRONMENTAL

Operating Temperature: 0–50° C  
(32–122° F)  
Storage temperature: 5–70° C  
(41–158° F)  
Operating Humidity: 15 to 80%  
Storage humidity: 10 to 90%

#### POWER

Base unit:  
Auto-adjusting power module;  
100–240VAC; 50/60 Hz

#### TELEPHONE CONNECTION

Analog PBX or PSTN line  
RJ-11C/CA11A, –12dBm nominal

#### KEYPAD

Alphanumeric standard keypad

#### LOUDSPEAKER VOLUME

90 dBspl A weighted @ 1 ft  
Bandwidth: 200Hz - 3.3kHz

#### RECORD OUTPUT

Connector: 2.5 mm mono audio  
jack  
Impedance: <1000 ohm  
Bandwidth: 200Hz–3.3kHz  
Dynamic Range: 60dB  
THD <.01%

#### ECHO CANCELLATION

Tail Time: 128 ms x 3

#### NOISE CANCELLATION

Dynamic noise cancellation

#### CERTIFICATIONS

FCC Part 15/ICES-003 Class A  
FCC Part 68/IC CS-03  
CE  
UL, C-UL Certified

#### WARRANTY

2 Years

#### MODELS

MAX EX\*  
MAX EX Expansion Kit\*

\*Call your sales representative for part numbers

## Compliance

### FCC Part 15/ICES-003 Compliance

This equipment has been tested and found to comply with the limits for a Class A digital device, pursuant to Part 15 of the FCC rules and Industry Canada ICES-003. These limits are designed to provide reasonable protection against harmful interference when the equipment is operated in a commercial environment. This equipment generates, uses, and can radiate radio frequency energy and, if not installed and used in accordance with the instruction manual, may cause harmful interference to radio communications. Operation of this equipment in a residential area is likely to cause harmful interference, in which case the user will be required to correct the interference at his/her own expense.

Operation is subject to the following two conditions: (1) This device may not cause interference, and (2) This device must accept any interference including interference that may cause undesired operation of the device.

Changes or modifications not expressly approved by ClearOne Communications could void the user's authority to operate the equipment.

### FCC Part 68 Compliance

US:FBIMT01B910158015 Ringer Equivalence Number (REN): 0.1B(ac)

This equipment complies with Part 68 of FCC Rules and Technical Requirements for Telephone Terminal Equipment published by ACTA. The marking on the base unit of this equipment contains, among other information, the US number and ringer Equivalence Number (REN) for this equipment. If requested, this information must be provided to your telephone company.

The REN is used to determine the quantity of devices, which may be connected to the telephone line. Excessive RENs on the telephone line may result in the devices not ringing in response to an incoming call. In most, but not all areas, the sum of the RENs should not exceed five (5.0). To be certain of the number of devices that may be connected to the line, as determined by the total RENs, contact the telephone company to obtain the maximum RENs for the calling area.

If this equipment causes harm to the telephone network, the telephone company will notify you in advance that temporary discontinuance of service may be required. If advance notice is not practical, the telephone company will notify the customer as soon as possible. Also, you will be advised of your right to file a complaint with the FCC if you believe it is necessary.

The telephone company may make changes in its facilities, equipment, operations, or procedures that could affect the operation of the equipment. If this happens, the telephone company will provide advance notice for you to make the necessary modifications in order to maintain uninterrupted service.

### Notice

A plug and jack used to connect this equipment to the premises wiring and telephone network must comply with the applicable FCC Part 68 Rules and Requirements adopted by the ACTA. A compliant telephone cord and modular plug is provided with this product. It is designed to be connected to a compatible modular jack that is also compliant. See installation instructions for details.

If you experience problems with this equipment, contact ClearOne Communications, 5225 Wiley Post Way, Salt Lake City, Utah 84116, or by phone at (801) 975-7200 for repair and warranty information. If the trouble is causing harm to the telephone network, the telephone company may request you remove the equipment from the network until the problem is resolved.

No user serviceable parts are contained in this product. If damage or malfunction occurs, contact ClearOne Communications for instructions on its repair or return.

This equipment cannot be used on telephone company provided coin service. Connection to Party Line Service is subject to state tariffs.

## IC Compliance

IC: 1970A-158015

Ringer Equivalence Number (REN): 0.1B(ac)

### Notice

The term "IC" before the certification/registration number signifies that Industry of Canada technical specifications were met.

This certification means that the equipment meets certain telecommunications network protective operational and safety requirements. The Department does not guarantee the equipment will operate to the user's satisfaction.

The REN is used to determine the quantity of devices, which may be connected to the telephone line. Excessive RENs on the telephone line may result in the devices not ringing in response to an incoming call. In most, but not all areas, the sum of the RENs should not exceed five (5.0). To be certain of the number of devices that may be connected to the line, as determined by the total RENs, contact the telephone company to obtain the maximum RENs for the calling area.

Before installing this equipment, users should ensure that it is permissible to be connected to the facilities of the local telecommunications company. The equipment must also be installed using an acceptable method of connection. In some cases, the companies inside wiring associated with a single line individual service may be extended by means of a certified connector assembly (telephone extension cord). The customer should be aware that compliance with the above conditions may not prevent degradation of service in some situations.

Repairs to certified equipment should be made by an authorized Canadian maintenance facility designated by ClearOne Communications. Any repairs or alterations made by the user to this equipment, or equipment malfunctions, may give the telecommunications company cause to request the user to disconnect the equipment.

Users should ensure for their own protection that the electrical ground connections of the power utility, telephone lines and internal metallic water pipe system, if present, are connected together. This precaution may be particularly important in rural areas.

## European Compliance

This equipment has been approved in accordance with Council Directive 1999/5/EC "Radio Equipment and Telecommunications Equipment"

See the enclosed Declaration of Conformity (DOC) that is enclosed with the equipment for full details. Compliance of the equipment with the Directive is attested by the application of the CE mark on the equipment.

## Warranty

ClearOne Communications, Inc. (Manufacturer) warrants that this product is free of defects in both materials and workmanship. For warranty information and coverage, refer to the ClearOne website at [www.clearone.com](http://www.clearone.com).

ClearOne Communications Inc.  
5225 Wiley Post Way  
Salt Lake City, Utah 84116